



# Lindab **Fastening and joining material**

Product overview

# For a better climate

Most of us spend the majority of our time indoors. Indoor climate is crucial to how we feel, how productive we are and if we stay healthy.

We at Lindab have therefore made it our most important objective to contribute to an indoor climate that improves

people's lives. We do this by developing energy-efficient ventilation solutions and durable building products. We also aim to contribute to a better climate for our planet by working in a way that is sustainable for both people and the environment.

[Lindab | For a better climate](#)

# Airtight with right fasteners

A screw is perhaps one of the smallest components in a duct system, but it's also a detail of significant importance. Lindab has a wide range of qualitative fastening material, offering everything from poprivets and screws, to bolts and nuts with the right function and quality for fastening your ventilation system. The right screw or rivet is also vital to achieve tightness class D in [Lindab Safe](#) duct system.



# lindQST – Lindab Quick Selection Tool

[lindQST](#) is an advanced web tool that makes the selection of our solutions quick and simple.



With lindQST all documentation is made available directly on the web. That means consultants, installers and architects always have access to the latest documentation, installation instructions and product images etc. lindQST is a unique online tool where you can simulate your room in the Indoor Climate Designer, keep track of your projects and share it with your business partners etc. lindQST provides a simple shortcut to Lindab's material and is a tool that speeds up and simplifies the daily work. All information is just a mouse-click away.



# Product overview



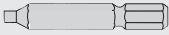

**Fastening materials**

**Fastening materials**

		
BITS	HYLSA	M6M
		
M6MF	M6S	M6SF
		
T6S	BRB	K41
		
K11-08-10	DYBH	







**Fastening materials**

**Joining materials**

		
RK	RE	RG RH
		
SH11 SH12	TG10 TG12	U41 U42
		
	U51 U52 U55	U41K U42K U63K

**Fastening materials**

**Tape**

		
ABT	AI TAPE	MT TAPE
		
PVC TAPE	RAI TAPE	UR TAPE

**Fastening materials**

**Sealants**



MASTIC

Click on the product for link to detailed technical information and accessories, or visit [www.lindab.com](http://www.lindab.com)

**Read next page to learn more about the tightness class D approved fasteners for Lindab Safe®.**

# Tightness class D approved fasteners for Lindab Safe®

Choosing the right screw or rivet is vital to achieve tightness class D in Lindab Safe duct system. Lindab recommend you to use the fasteners below:

To be sure to achieve tightness class D in your duct system follow these steps:

## 1. Correct mounting of Lindab Safe

Mount your duct system according to the mounting instruction for Lindab Safe.

Scan the QR code for mounting instruction.



## 2. Correct number of fasteners

Minimum number of fasteners required to achieve sufficient strength is presented in the table below.

Duct Ø [mm]	Minimum number of fasteners
63-112	2
125-224	3
250-630	4
710-1250	6
1400-1600	10

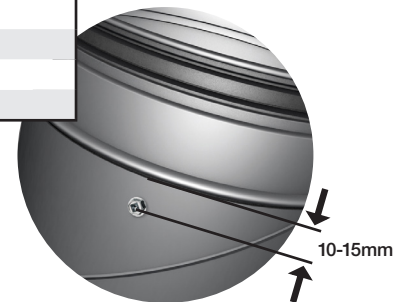

## 3. Correct sizes of fasteners

Recommended length and diameter presented in the table below.

Dim	Screw		Blind rivet	
	Lenght [mm]	Diameter [mm]	Length [mm]	Diameter [mm]
63-250	9,5	4,2	8	3,2
250-630	13	4,2	9,5	4
710-1250	13	4,2	14	4,8
1400-1600	16	4,8	18	4,8

### **i** Screw with sharp tip

U51, U52



- Stable head and bit to ensure easy mounting
- Brake under the head to prevent spinning
- Sharp tip to not damage the sheet steel for better stability
- Sharp tip to be able to screw tilted
- Thread all the way up to be strong

### **i** Screw with reduced drilltip

U41, U42, U41K, U42K, U63K



- Stable head and bit to ensure easy mounting
- Brake under the head to prevent spinning
- Thin drill tip to not damage the sheet steel for better stability
- Thread all the way up to be strong

### **i** Pressure-tight blind rivet

RG12, RG22, RG32



- Airtight
- Strong
- When screws are not allowed



Most of us spend the majority of our time indoors. Indoor climate is crucial to how we feel, how productive we are and if we stay healthy.

We at Lindab have therefore made it our most important objective to contribute to an indoor climate that improves people's lives. We do this by developing energy-efficient ventilation solutions and durable building products. We also aim to contribute to a better climate for our planet by working in a way that is sustainable for both people and the environment.

[Lindab | For a better climate](#)